

CALogix

MODULAR LOGIC AND PROCESS CONTROL



CALogix

CAL Controls is known for developing pioneering temperature and process control products. CAL has led the market by developing innovative products such as the world's first 1/16th DIN (48 x 48mm) analogue and digital controllers followed by the first 1/32nd DIN (48 x 24mm) controller.

CALogix is another new concept from CAL where multi-loop temperature and process control is integrated with logic functionality in a compact, modular DIN-rail mount unit.



CALogix has benefits for OEMs and panel builders through to end users. System design is simplified with greater control and data monitoring achievable.

- Improved system control
- Reduced maintenance times
- Increased system flexibility

CALogix Applications

Integrated PID & Logic for Advanced System Control

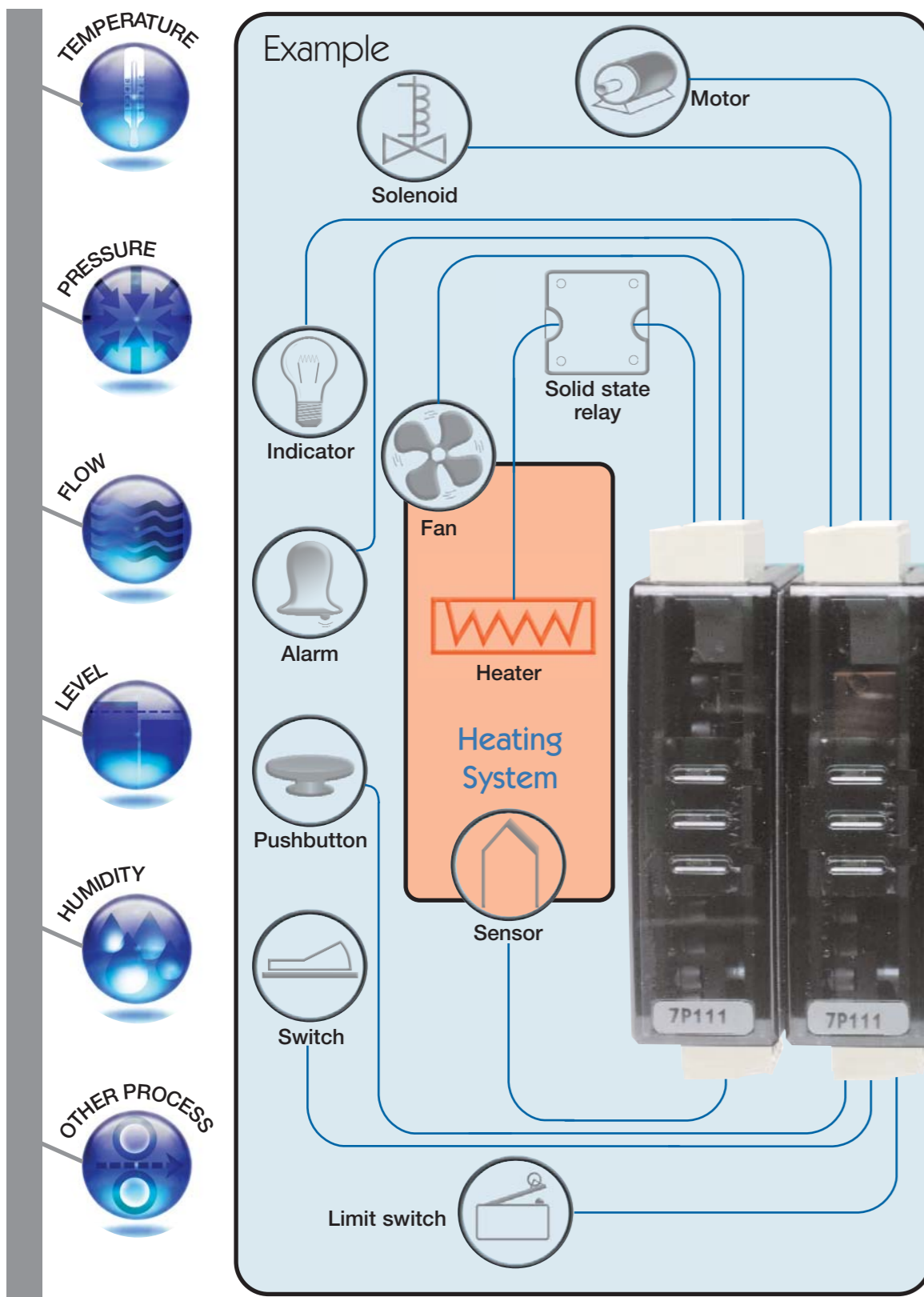

A true Process Controller

The modular CALogix allows you to integrate different process control loops in to one system for example, pressure and temperature may need to interact with each other

PID Control



- PID control with auto-tune
- Programmable profiles
up to 31 profiles per module
maximum 126 segments per profile
(ramps, soaks, loops, event input/outputs)
- Temperature sensor or analogue inputs
- Integration with logic functions

Logic control



- Boolean
(and, or, nand, nor, xnor, latch)
- Timers
(on-delay, off-delay, on-pulse, off-pulse, on-off delay, on-off pulse, delayed pulse, a/symmetrical recyclers)
- Counters
(up counter, high speed up counter)
- Comparators
(compare 2 inputs)

System flexibility to provide complete control

CALogix is a modular system that consists of a DIN-rail mounted base-unit and up to 4 control modules. PID and Logic modules can be added to the base-unit in any configuration ensuring that the exact requirements for your application can be met.



Centralised monitoring and control

As an alternative to conventional panel mount controllers, CALogix is a DIN-rail mounted sub-panel device. This means that CALogix is easy to integrate within a system that has a central user interface. This could be an operator panel or a PC running an OPC based SCADA system or your own bespoke software.

CALogix Operator Panel



PC based system (eg. CALgrafix) for:

- Chart recording
- Data-logging
- Alarms
- Displays/mimic
- Recipes



Connect up to 31 base-ur per network

An ideal solution for your application

CALogix provides cost-effective multi-loop control in many applications including plastics machines, automated control systems, analytical systems, environmental chambers, ovens, kilns, furnaces, packaging equipment and many other temperature or process control applications.

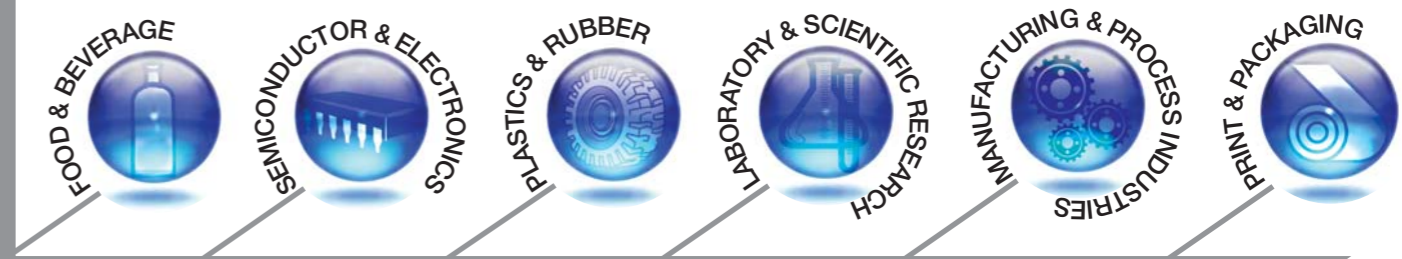

Modular Logic and Process Control

...PID Control...

...Logic Control...

...Advanced Control



Base-unit

Power supply, CPU and communications are integrated within the base-unit. A maximum of 4 control modules can be added to the base-unit.



PID Modules

PID modules are available with sensor (Thermocouples, RTD 2/3 wire, 0-50mV), 4-20mA, 0-5V or 0-10V inputs

There are 3 outputs on the module that are a combination of relay, SSR driver, 4-20mA, 0-5V or 0-10V.



I/O Modules

I/O modules integrate with logic functionality and PID for additional system inputs and outputs.

There are three inputs that are selectable as 0-5V, 0-10V or 0-24Vdc. The modules have relay or solid state 12Vdc output options.

Easy to install

DIN-rail mounting and removable terminals simplify installation and maintenance. Status and activity LED's assist when commissioning and testing.



Reduced maintenance times

Modules have quick release tabs and plug-in terminals for fast removal. Once a new module is installed it is automatically reconfigured by the base-unit, no reprogramming is required!

Communications

Up to an additional 31 base-units (124 PID loops) can be networked using RS485 communications, with the Modbus RTU protocol. Two RJ45 connectors allow simple looping in and out of networked units.

Configuring CALogix is so simple...

PID configuration

A graphical interface gives real-time process values and set-point data for each PID module. Structured drop-down menus provide a simple platform for configuring all the functions within the PID module.

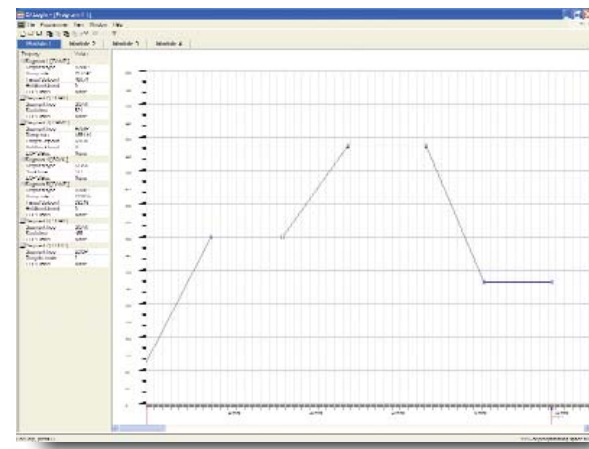
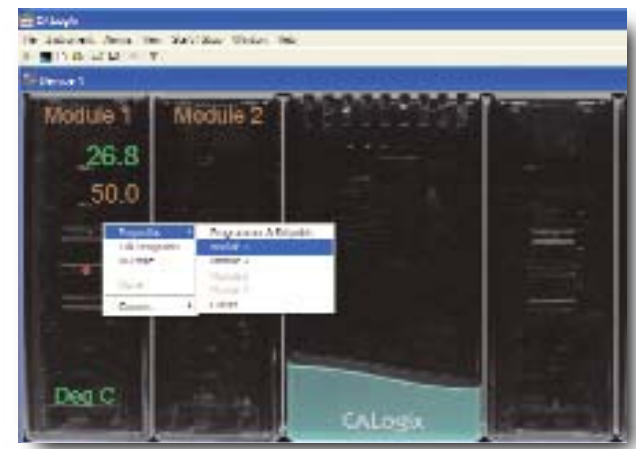

Profile creation

Programs can be created quickly by using CAL's unique drag'n'drop profile creation tool. Segments such as ramp, soak (dwell), step, loop, call and event inputs & outputs can be included. CALogix is configured using CALogix-sw, an easy-to-use software utility provided with the base-unit.

Function block logic programming

Timers, counters, boolean and comparator function blocks can be linked with inputs, outputs and PID for enhanced system control. Up to 42 logic blocks and 16 timers and counters per base-unit.

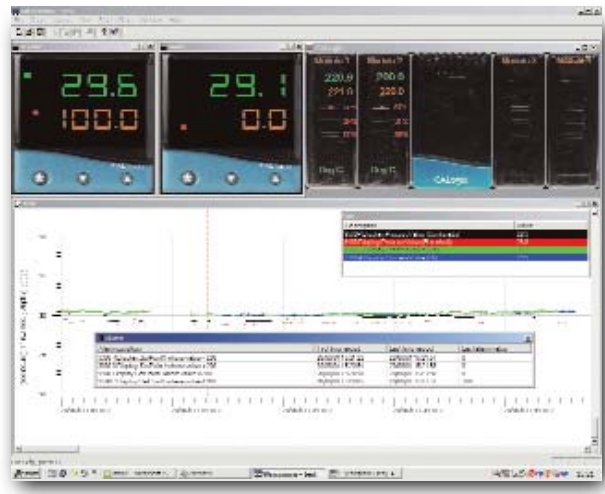
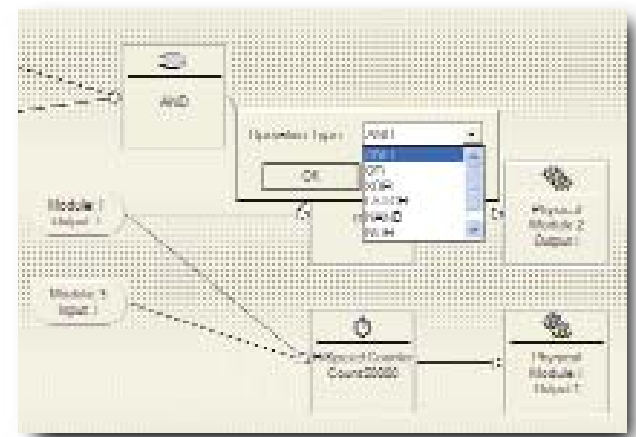

CALgrafix - charting and logging of data

CALgrafix configuration and process monitoring software has charting, logging and alarm features in addition to the configuration tools within CALogix-sw. With OPC technology CALgrafix professional version can also be networked.

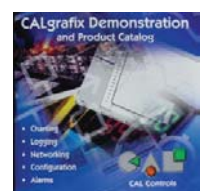

ASK FOR THE BROCHURE AND DEMO CD

CALopc - OPC Server

CALogix can be integrated with 3rd-party software that has OPC client-server compliance. Ideal with SCADA and other systems.



Starter kit

Everything you need to get started with CALogix is included in our starter kit;

- Base-unit
- PID Module (sensor input, ssd/relay/relay output)
- Logic Module (3 x Relay output)
- CALogix-sw configuration software
- RS232/485 converter
- Programming manual
- CALogix programming cable
- 2A, 24Vdc DIN-rail power supply



Accessories



RS232/485 Converter



2A, 24Vdc DIN-rail Power supply

Specification

PID Module specifications

Thermocouple – 9 Types - B, E, J, K, L, N, R, S, T

Standards	IEC 584-1
CJC rejection	30:1 typical
External resistance	100Ω maximum

Resistance Thermometer – 2 or 3 Wire

Standards	IEC 751 (100Ω 0°/138.5Ω 100°C Pt)
Bulb current	0.2mA maximum

Linear Process inputs

Linear input	Typical accuracy	Range
0-50mV	±0.1%	± 0.00 - 99.99, ±100.00 - 499.95, ±500 - 999.9, ±1000 - 9999
4-20mA	±0.1%	As above
0-5V	±0.1%	As above
0-10V	±0.1%	As above

Applicable to all inputs (SM = Sensor maximum, FS=full scale)

Calibration accuracy	±0.1% FS typical ±1°C
Sampling frequency	Input 10Hz, CJC 4sec
Common mode rejection	Negligible effect up to 140dB, 240V, 50-60Hz
Temperature coefficient	50ppm/°C SM typical

Output devices

Solid state relay driver : SSd1 and SSd2	12Vdc +10/-15% 20mA
Miniature power relay: Rly1, Rly2, Rly3	2A/250Vac resistive load, form A/SPST
Analogue output	4-20mA 500Ω max ±0.1% FS typical 0-5Vdc 10mA 500Ω max ±0.1% FS typical 0-10Vdc 10mA 1KΩ max ±0.1% FS typical

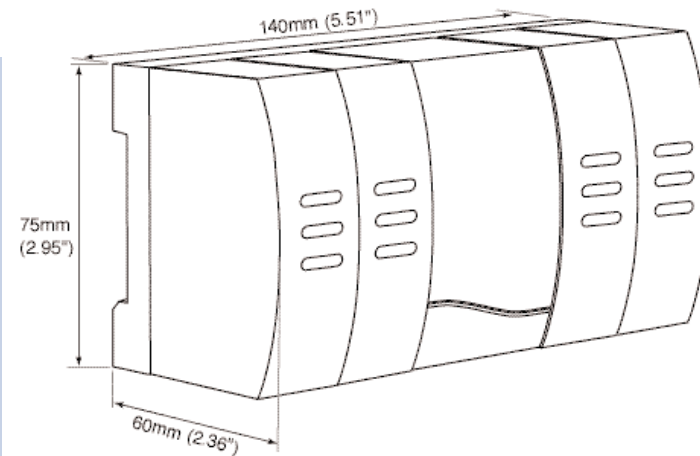

Logic I/O Module specifications

Input range	0-5/0-10/0-24Vdc (s/w select)
Outputs	SSd1 and SSd2 Rly1, Rly2, Rly3
	12Vdc +10/-15% 20mA 2A/250Vac resistive load, form A/SPST
Maximum counter input frequency	1 fast 1KHz, Other 10Hz

Environmental

Safety	EN61010, UL & CSA approvals pending
Installation	Categories I and II
Pollution	Degree II
EMC emission	EN61000-6-3
EMC immunity	EN6100-6-2
Mouldings	Flame retardant polycarbonate

Supply

Supply voltage	18-30Vdc, 8watts ±10% fluctuation allowed
----------------	--

Operator panels



CALogix operator panels

The CALogix range of operator panels can be integrated as a user interface for CALogix. The easy-to-use CALogix-sw software tool configures the panel so that system data can be monitored, set-points and parameters adjusted, perform control functions or run selected profiles.

Other network devices can also be monitored and controlled with CALogix, providing complete system control from a single interface.

- Keypad or touch-screen options
- Available with monochrome or colour screens
- CALogix-sw for easy configuration

Model	ePAD04	ePAD05	eTOP03	eTOP11
Display	LCD Monochrome	LCD Monochrome	LCD Monochrome	STN Colour
Graphic Resolution	120 x 32	120 x 32	320 x 240	320 x 240
Rows/Columns of text	4 x 20	4 x 20	16 x 40	16 x 40
Scalable fonts	Yes	Yes	Yes	Yes
User definable characters	256	256	256	256
Memory				
User memory	512KB	512KB	512KB	8MB
Front Panel				
Function keys	4	10	No	No
System keys	7	9	No	No
Touch-screen	No	No	Analogue resistive	Analogue resistive
Connections				
Controller Port	RS232/422/485	RS232/422/485	RS232/422/485	RS232/422/485
Aux Port	Optional module	Optional module	Optional module	Optional module
Functionality				
Number of variables per page	Unlimited	Unlimited	Unlimited	Unlimited
Recipe memory	No	16KB	32KB	32KB
Alarms	1024	1024	1024	1024
Event list	No	256	256	1024
Alarm info page	Yes	Yes	Yes	Yes
Passwords	Yes	Yes	Yes	Yes
Battery	No	Yes	Yes	Yes
Hardware real time clock	No	Yes	Yes	Yes
Power supply voltage	18-30Vdc	18-30Vdc	18-30Vdc	18-30Vdc
Power consumption @ 24Vdc	250mA	250mA	400mA	600mA
Protection class (front panel)	IP65	IP65	IP65	IP65
Dimensions (W x H x D mm)				
Cut-out (W x H mm)	149x109x53 136x96	149x109x53 136x96	149x109x61 136x96	187x147x91 176x136

Ordering information

CALogix

Base-unit Including CALogix-sw	7C 000 00 400
CALogix/PC cable, 2m (RS485)	CAB RJ45 2M 01
RS232/485 Converter	3C 25 000 K 3X
CALogix starter kit	7S 1111 AAA 11 000
Blank module	097 004

CALogix Modules

CALogix Modules		PID Module	Logic I/O
Model		7P	7L
Outputs 1, 2 & 3	ssd/relay/relay	211	211
	relay/relay/relay	111	111
	ssd/ssd/relay	221	221
	4-20mA/relay/relay	B11	-
	4-20mA/ssd/relay	B21	-
	0-5V/relay/relay	C11	-
	0-5V/ssd/relay	C21	-
	0-10V/relay/relay	D11	-
	0-10V/ssd/relay	D21	-
Unused		0	0
Inputs	Sensor	A	-
	4-20mA	B	-
	0-5V	C	-
	0-10V	D	-
	5/12/24Vdc	-	E
Unused		000	000

Ordering example 1: PID module 4-20mA/ssd/relay outputs, sensor input

7P B21 0 A 000

Ordering example 2: I/O module relay/relay/relay outputs, 5/12/24Vdc Inputs

7L 111 0 E 000

CALopix Operator Panel

ePAD04 operator panel 11 keys	7H 000 A 0 000
ePAD05 operator panel 19 keys	7H 000 B 0 000
eTOP03 LCD mono touch-screen 3.8"	7H 000 C 0 000
eTOP11 STN color touch-screen 5.6"	7H 000 D 0 000
CALopix-sw configuration software	10 07 GB 000
HMI/PC Cable, 2m	CAB D15 9 2M 01
HMI/CALogix cable, 3m	CAB RJ45 3M 02

Power supply

2A, 24Vdc DIN-rail power supply	7V 02A 0 0 000
---------------------------------	----------------

Specifications are subject to change without notice, as a result of continual development and improvement, E&OE

Your nearest CAL contact:

ThermX Southwest

800-284-3769

CAL Controls Ltd
 Bury Mead Road, Hitchin, Herts, SG5 1RT, UK
 Tel: + 44 (0) 1462-436161 Fax: + 44 (0) 1462-451801
 email: sales@cal-controls.co.uk

CAL Controls Inc
 1117 S. Milwaukee Avenue, Libertyville, IL 60048, USA
 Tel: (847) 680-7080 Fax: (847) 816-6852
 email: sales@cal-controls.com

www.cal-controls.com